



Wine Cellar Cooling Systems Through-the-Wall Wine Cellar Cooling Systems Installation, Operation and Maintenance Guide

60Hz Models TTW009/TTW018

50Hz Models WG15/WG25

Manufactured by:



AIR INNOVATIONS Syracuse, NY

www.wineguardian.com

www.airinnovations.com

Wine Guardian reserves the right, without notice, to make changes to this document at its sole discretion. Please visit our web site for the most current version of the Wine Guardian manual and other literature.

Wine Guardian is a registered trademark (2,972,262) of Air Innovations, Inc.

Wine Guardian Through-the-Wall U.S. Pat. No. D634,760S

Edition 5-2017

© Air Innovations, 2017

Part No.
15H0184-00

TABLE OF CONTENTS

Directory of Terms	4
Receiving, Inspecting and Unpacking the Wine Guardian System	5
Review the Packing Slip to Verify:	5
Check the unit for.....	5
General Description	6
Wine Guardian Controls	7
Wine Guardian Controls	8
Standard Specifications	9
The Wine Guardian System Contains.....	9
Accessories and Optional Equipment	10
Installation Sleeve	10
Extended Compressor Warranty---U.S. and Canada only	10
Duct Collar Adapter.....	10
Remote Temperature/Humidity Controller	10
Remote Temperature/Humidity Sensor	10
Heater Option	10
Humidity Option.....	11
Remote Temperature/Humidity Sensor	11
Serving Temperature Option	11
Overview of the Wine Guardian Unit.....	11
Overview	13
Safety	18
Safety Message Conventions.....	18
Danger	18
Warning.....	18
Caution.....	18
Lockout/Tagout Procedure	19
Safety Considerations	19
Safety Hazards	19
Electrical Hazards	19
Electrical Shock Hazards.....	19
Hot Parts Hazards	19
Moving Parts Hazards.....	20
Equipment Safety Interlocks.....	20
On/Off Switch	20
Installation	22
Pre-installation Test.....	22
Air Flow Illustration	22
Planning the Installation.....	23
Performing a Pre-installation Check.....	24
Locating the System.....	24
Power Cord Location	24
Grilles.....	27
Mounting the System	27
Installing the Condensate Overflow	28

Installing the Drain Line	29
Priming the Drain Trap.....	29
Wiring the System for Power	29
Electrical Plug Configuration 60Hz Models Only	30
Installing the Thermostat and Communication Cable	31
Mounting the Optional Remote Interface Controller	31
Installation of the Optional Wine Guardian Remote Sensor	33
Mounting the Remote Sensor	33
Joining Communication Cable	35
Changing Jumper Positions (Averaging readings from Remote Sensor)...	35
Standard Controller Functions	36
Starting-up and Operating the Wine Guardian	42
Control Settings	42
Controller Functions	42
Regulating the Wine Cellar Temperature	43
Changing the Air Flow Direction	43
Maintenance	43
Maintenance Schedule	44
Monthly	44
Yearly	44
High Pressure Switch has Shut the System Down	45
Instructions to Reset High Pressure Switch	45
Alarm Annunciation.....	45
Troubleshooting.....	46
Typical Start-up Problems	46
Unit Does Not Start-up.....	46
Unit is Operating and Blows Evaporator Air, but the Supply Air is not Colder than the Return Air from the Cellar.....	47
Problems Controlling Cellar Temperature.....	47
Problems Controlling Cellar Humidity	48
Problems Controlling Cellar Humidity	49
Other Miscellaneous Problems.....	49
Manufacturer's Warranty – U.S. and Canada only	50
Through-the-Wall Return Policy for U.S. and Canada only.....	51
Contact Information	52

Directory of Terms

Ambient Air – The surrounding area outside the cellar such as a room, basement, garage or outdoors.

CFM – Cubic feet per minute. A unit of measurement for the amount of air handled by the fan.

Condensate / Condensation – The water formed out of the air when it is cooled below a certain temperature (called dew point). Often referred to as “sweating” on pipes and cold surfaces. This water collects at the bottom of the evaporator or cooling coil and drains out of the unit through the drain line.

Condenser (Heat Rejection) Section / Coil – The Condenser Section uses the compressor, condenser coil and fan to remove heat from the refrigerant to the ambient air *outside* the wine cellar. The word condenser refers to the condensation of the refrigerant from gas to liquid phase.

CSA/ETL – Canadian Standard Association/Electric Testing Laboratory

CE – Certificate of European conformity

Exhaust Air – The air leaving the evaporator or condenser section of the Wine Guardian unit.

Evaporator (Cooling) Section / Coil – The Evaporator Section uses the cooling coil and the fan to remove heat from the air *inside* the wine cellar to the refrigerant, cooling the air and condensing moisture out of the air. The word evaporator refers to the evaporation of the refrigerant from liquid to gas phase in the coil. The Evaporator Section is connected to or inside the wine cellar.

Flexible Duct – Round ducts with steel reinforced plastic liners, a layer of insulation and an outer plastic layer used to convey the air from the unit to the cellar or ambient space.

Grille or Diffuser – Inlet or outlet plates to direct the airflow or protect the inside of the unit.

Heat Gain / Loss – The amount of cooling or heating expressed in watts transferred between the wine cellar and the ambient space. The Wine Guardian must offset this load.

Inlet Air – The air entering the evaporator and condenser sections of the Wine Guardian unit.

NEC – National Electrical Code

Recovery – The amount of cooling the unit does to return the cellar to its set point temperature after some new load is introduced, such as people or new cases of warm wine entering the cellar.

Return Air - The air leaving the cellar and returning to the inlet of the evaporator coil.

SP – Static pressure. Unit of measurement (inches of water column) of the pressure of the air handled by the fan.

Set Point – The desired temperature or humidity set on the thermostat or humidistat.

Supply Air - The air entering the cellar from the discharge of the evaporator coil.

Receiving, Inspecting and Unpacking the Wine Guardian System

NOTE: Wine Guardian systems are factory assembled and tested prior to shipment.

Wine Guardian systems are shipped individually in corrugated boxes specially designed to protect the equipment during shipment.

- ✓ Before opening the container, inspect the packing crates or boxes for obvious signs of damage or mishandling.
- ✓ Write any discrepancy or visual damage on the bill of lading before signing.
- ✓ Inspect all equipment for any sign of damage caused during transit.
- ✓ Report all visual or concealed damage to the carrier and file a claim immediately.

IMPORTANT

If this procedure is not followed, the shipping company may reject the claim and the consignee may suffer the loss. Do not return the shipment to the factory.



WARNING



*** DO NOT LIFT THE UNIT UP FROM ITS PLASTIC FRONT PIECES TO AVOID DAMAGING THEM**

****THE UNIT SHOULD BE LIFTED FROM UNDERNEATH ITS BASE AT BOTH ENDS OF THE SYSTEM.**

Review the Packing Slip to Verify:

- ✓ Model number
- ✓ Factory-installed options
- ✓ System accessories

If any items listed on the packing slip do not match your order information, contact the place of purchase immediately.

Check the unit for:

- ✓ An electrical power cord (factory installed on condenser side)
- ✓ The Easy Mount™ Through-the-Wall mounting sleeve.
- ✓ Accessories such as condenser air duct collar or duct collar kit, and optional controls, if ordered.

General Description

The Through-the-Wall Wine Guardian cooling system is a professional grade, self-contained climate control system designed specifically for the storage of wine at cellar temperatures. It is designed for easy installation and operation. Wine Guardian uses digital electronic controls and environmentally friendly R-134a refrigerant. The entire system is run-tested at the factory and shipped as a single package. All components are of a high quality standard commercial grade. The entire system is approved by ETL (Equipment Testing Lab) according to UL (Underwriters Laboratory) 484 and CSA (Canadian Standard Association) safety standards. All wiring complies with NEC (National Electrical Code). All 50Hz Wine Guardian equipment is CE certified. Each system is factory installed with a sealed, UL-approved power cord and plug that can be mounted on either end of the cooling system. Wine Guardian products are made in the USA.

The Wine Guardian Through-the-Wall system is completely self-contained and includes an integral air cooled condenser. The system is functionally divided into two sections, the evaporator or cooling section, and the condenser or heat rejection section. Each section contains a coil to add or remove heat and a fan to move the air through the coil and into or out of the cellar or adjacent space.

Air from the cellar first enters the cooling coil. Air passes through the cooling coil and is cooled by the refrigerant inside the coil. This causes any excess humidity in the air to condense and be captured in the drain pan and internally evaporates as it comes in contact with the integral condensate removal coil. Air then enters the fan where it is pressured and discharged out of the system. The thermostat, located on the system, or through the optional remote interface controller, turns the cooling on and off as needed to maintain its set point.

The compressor and condenser section are activated whenever the system is cooling. The condenser fan draws air from the surrounding or ambient space. The airflow through the condenser coil where it absorbs heat from the refrigerant in the coil. The air is finally discharged out of the system by the condenser fan, and can be ducted outside or to an unused space by an optional condenser duct kit.



THE AIR EXHAUST FROM THE CONDENSER FAN IS WARM AND CAN BE 20 DEGREES F ABOVE THE ENTERING AIR TEMPERATURE.

Wine Guardian Controls

Wine Guardian's digital electronic control system offers a versatile solution for controlling and monitoring your wine cellar temperature and humidity. This system consists of four controls; a main control board; a local user interface; a remote user interface; and a remote temperature and humidity sensor. The system only required the use of the main control board and one of the user interfaces (local or remote) to function. However, users have the following options to customize the control capabilities for their application: (See pg. 8 for description of control boards and optional sensors).

The Wine Guardian's digital electronic controls are designed to control the operation of the compressor, condenser fan, evaporator fan, and optional humidifier. There also is pressure switch monitoring with a dry contact alarm output that will energize in the event of a pressure switch fault or a high/low temperature or humidity alarm. The local and remote user interface controls employ user-friendly, menu-driven programming features that can easily be accessed by holding the mode button on the control for five seconds. Once in the program menu, the user can scroll through the setting by pressing the mode button and can adjust each setting by using the up and down arrows. The programming mode allows the user to customize features such as °F or °C temperature scale, high/low temperature and humidity alarm set points, an adjustable 0-10 minute compressor anti-short cycle delay, sensor averaging options, enable or disable the defrost feature, an optional keypad lockout code, differential and dead band adjustments, room temperature calibration, enable or disable the humidifier, and automatic or continuous fan option. To exit the programming mode the user may either hold the mode button for 5 seconds or the control will automatically store the settings and exit the programming mode after 10 seconds of inactivity. Each user interface control will also employ an ON/OFF button that turns the system on or off respectively.

Wine Guardian Controls

Main Control: Performs all switching functions and interfaces with inputs and outputs. It can connect to local or remote user interface, as well as remote temperature/humidity sensor.



Two way communications: local user interface reports settings back to main control, main control energizes outputs and reports alarms and temp/humidity readings to local user interface.

Two way communications: remote user interface reports settings back to main control, main control energizes outputs and reports alarms and temp/humidity readings to remote user interface.

One-way communication: remote temp/humidity sensor reports temp and humidity readings to main control.



Default to 13 Deg C for 50Hz models

Local User Interface: Can be used with Main Control for adjusting settings, reading temp/humidity, and reading fault codes at the unit.

Remote User Interface: Can be with Main Control for adjusting settings, reading temp/humidity, and reading fault codes in a remote location away from the unit.



Temperature/Humidity Sensor: Can be used in conjunction with the Main Control to report temp/humidity from inside the wine cellar without requiring a user interface to be located inside the wine cellar.

Standard Specifications

IMPORTANT

Design and specifications are subject to change without notice

The Wine Guardian System Contains

- ✓ A capillary tube expansion to control the flow of refrigeration into the evaporator coil
- ✓ A filter dryer to keep the refrigerant clean and free of contaminants
- ✓ Dual factory mounted plastic supply/return air grilles for evaporator and condenser air movement
- ✓ Movable supply air louvers for side-to-side directing of cold air into the wine cellar
- ✓ A manually reset, high-pressure switch on the condenser discharge to protect the compressor from high pressures
- ✓ Environmentally friendly-134a refrigerant
- ✓ An internally/externally mounted digital electronic control with many user-controlled settings
- ✓ Auxiliary drain port connection at condenser end of unit

All exterior framing of the Wine Guardian is powder coated, 0.063" gauge aluminum to prevent rust and corrosion. All coils are aluminum tubes with aluminum fins. The system uses an internal drain system to remove excess moisture and does not reintroduce it back into the cellar. An auxiliary drain port is located at the condenser end of the unit should there be a need to physically remove the excessive moisture.

Each system is provided with a pre-wired and tested electronic digital thermostat (local user interface) as standard, or an optional remote mounted thermostat (remote user interface) in the wine cellar. The thermostat has multiple control functions for the fan, operation, cooling (if equipped), and maintaining humidity.

Compressors are self-lubricating, permanently sealed, hermetic reciprocating type compressors, with internal overload protection and capacity start with a minimum of one-year manufacturer's warranty and an optional five-year warranty. Compressors are mounted on rubber-in-shear isolators to reduce noise and vibration.

Electric power is supplied by a single, factory-furnished cord and plug that can be connected on the cellar side or the condenser side of the unit. Units are shipped from the factory with a plug attached on the condenser side. All controls are 24-volt supplied from an internal transformer.

Accessories and Optional Equipment

Installation Sleeve

Each Wine Guardian system includes an EasyMount™ installation sleeve to be used in the mounting of the system through-the-wall at the desired location. The sleeve is essential for the proper support of the Wine Guardian system and ease of installation. The maximum dimensions of the wall opening should be 14½” wide by 16¼” high (36.83cm wide by 41.28cm high).

For proper operation of the system, including drainage and undue noise and vibration, the Installation Sleeve must be mounted level within the wall cutout and securely fastened to the wall studs on either side of the sleeve as shown on page 27.

Extended Compressor Warranty---U.S. and Canada only

The Wine Guardian uses only the best commercially available compressors on the market. However, since the compressor is the single most expensive component in the system, it is recommended that you purchase the extended, five-year warranty option.

Duct Collar Adapter

An optional duct collar kit is available for ease in directing the warm condenser air away from the through-the-wall unit mounting. The kit includes one (1) duct collar, 15-foot (4.5 meters) of 6-inches (15.24cm) round flexible ductwork and two (2) tie wraps for connection of the ductwork to the duct collar. The kit does not include connections at the tie-in point to the remote location or outdoors.

Remote Temperature/Humidity Controller

The remote temperature/humidity controller (Remote Interface Controller) is intended to provide a means for user interface at a remote location. The controller can be used as a remote sensor/controller mounted within the wine cellar remote from the Through-the-Wall system. The controller can also be used as a remote indicator (without sensor) mounted directly outside of the wine cellar of the residence or building. The Remote Interface Controller includes a backlit face for temperature and humidity indication along with controller set-up and operational functions.

Remote Temperature/Humidity Sensor

The remote temperature/humidity sensor is intended to provide a means of sensing one or more locations within the wine cellar and designed to work in conjunction with the Remote Interface Controller or Local Interface Controller integral to the Wine Guardian Through-the-Wall system. Multiple sensor readings are averaged and controlled to a single point. The sensors do not have any temperature or humidity indication and must be mounted within the wine cellar.

Heater Option

The electric heat option includes an integral electric heating element, thermal overload protection device and controls. The Wine Guardian will either cool or heat the air, but it is not designed to do both at the same time. The Wine Guardian electric heat option must be specified at time of order and installed at our factory.

Humidity Option

An optional stand-alone humidifier comes fully assembled and tested for field installation. It automatically adds moisture into the cellar by the evaporation of water over a distribution pad.

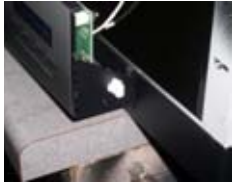

Humidifier Connection: You can locate the low voltage connection for field optional remote humidifier on side of control panel on the wine cellar side of the WG cooling unit. The optional humidifier comes pre-wired to fit directly to this connection for the WG unit to control cellar humidity level desired.

Serving Temperature Option

The factory configured serving-temperature option allows a Wine Guardian unit to control to an extended temperature range from 42° F to 64° F (5°C - 18°C). Perfect for single to multiple cabinet applications and small wine rooms in which consumption-temperature cooling is preferred. It also allows the user to rotate wine stock and change the set point from season to season, making it ideal for restaurants, wine bars, clubs, etc.

Overview of the Wine Guardian Unit

Refer to illustrations on page 13

Cabinet – The cabinet is constructed of aluminum with a powder coated finish for corrosion protection and an attractive, maintenance-free appearance. Areas in contact with cold temperatures are lined with insulation to prevent condensation.

Condensing Section - Ambient air is circulated through the condenser section by a direct drive, permanently lubricated, motorized impeller blower. This section also contains the compressor and the electrical controls.

Evaporator Section – Wine cellar air is circulated through the evaporator section by a direct drive, permanently or lubricated motorized impeller blower. The large evaporator coil face area eliminates condensate carry-over, reduces air pressure drop and optimizes heat transfer. A drain pan is located directly below the coil to capture condensate and is fabricated from aluminum to prevent rust and corrosion.

Electrical Controls – All solid state electronic controls are connected internally and/or externally through a phone cord-type connection. There is no need to open the chassis to access the factory mounted and wired control. All internal wiring is in accordance with the National Electrical Code. Wires are numbered and color coded to match the wiring diagrams.

Factory Tested – All Wine Guardian units are factory run-tested and checked for operational performance.

Internal Drain – Condensate from the evaporator coil is directed to the condensate removal system at the condenser end of the unit. This allows the drain pan to drain freely. No external trap is required.

Refrigerant Circuit – The factory-charged circuit includes a capillary tube expansion device, a filter dryer, and a manual reset high pressure switch. **See Refrigeration Illustration on page 13.**

Supply/return grilles – These are made of rugged ABS plastic and factory mounted to automatically seal to the chassis. Air is introduced through the sides and bottom and discharged through the front perforated section.

Directional Louvers – Two directional louvers are located within the evaporator supply air discharge opening on the Wine Guardian unit and can be accessed by removal of the wine cellar side faceplate. The louvers are designed to be manually adjusted to direct air flow from side-to-side or straight on. The louvers can help direct cold air into the center of the wine cellar should the Through-the-Wall unit be mounted in a corner of the room.

Overview

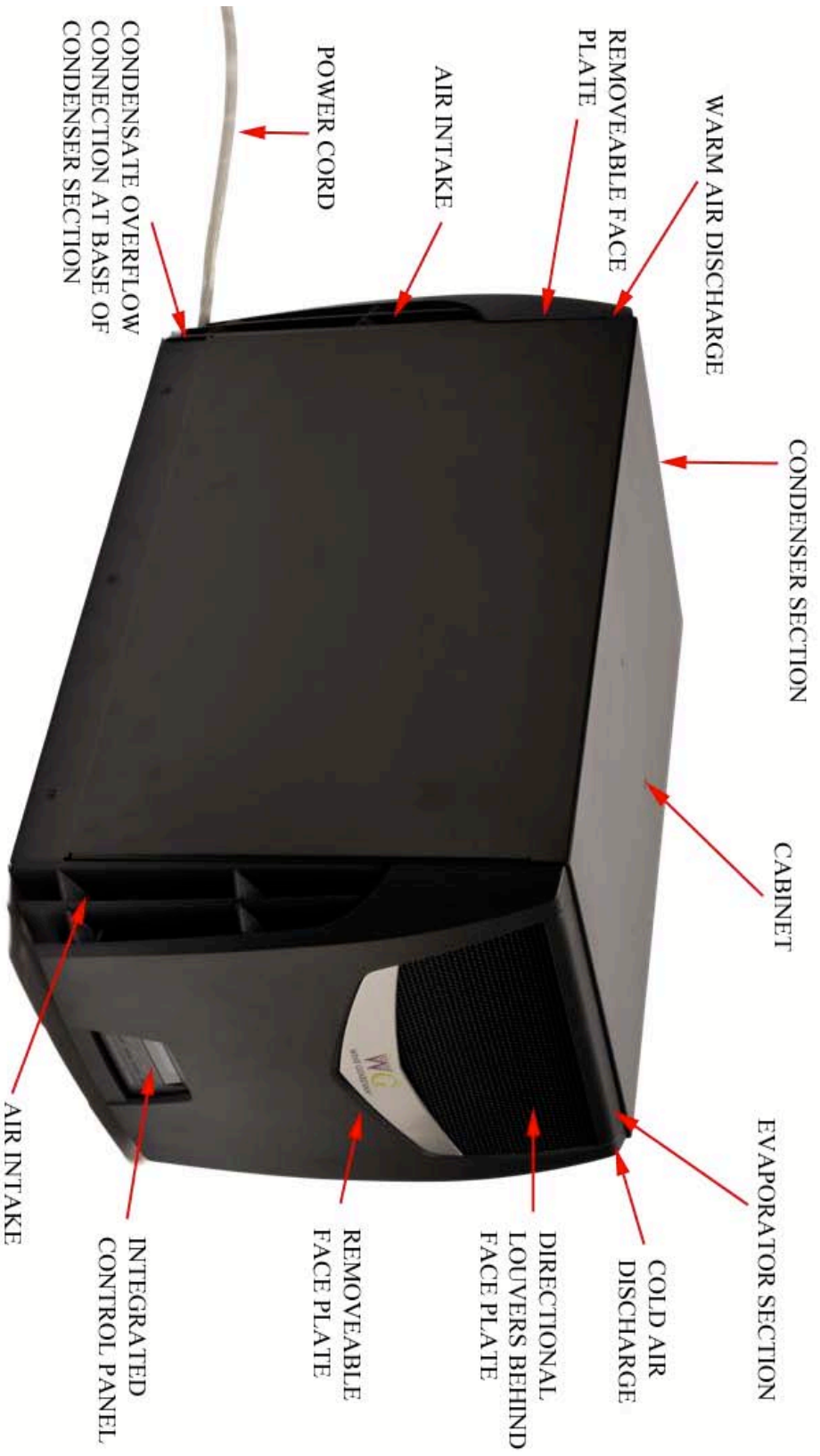

TTW 018

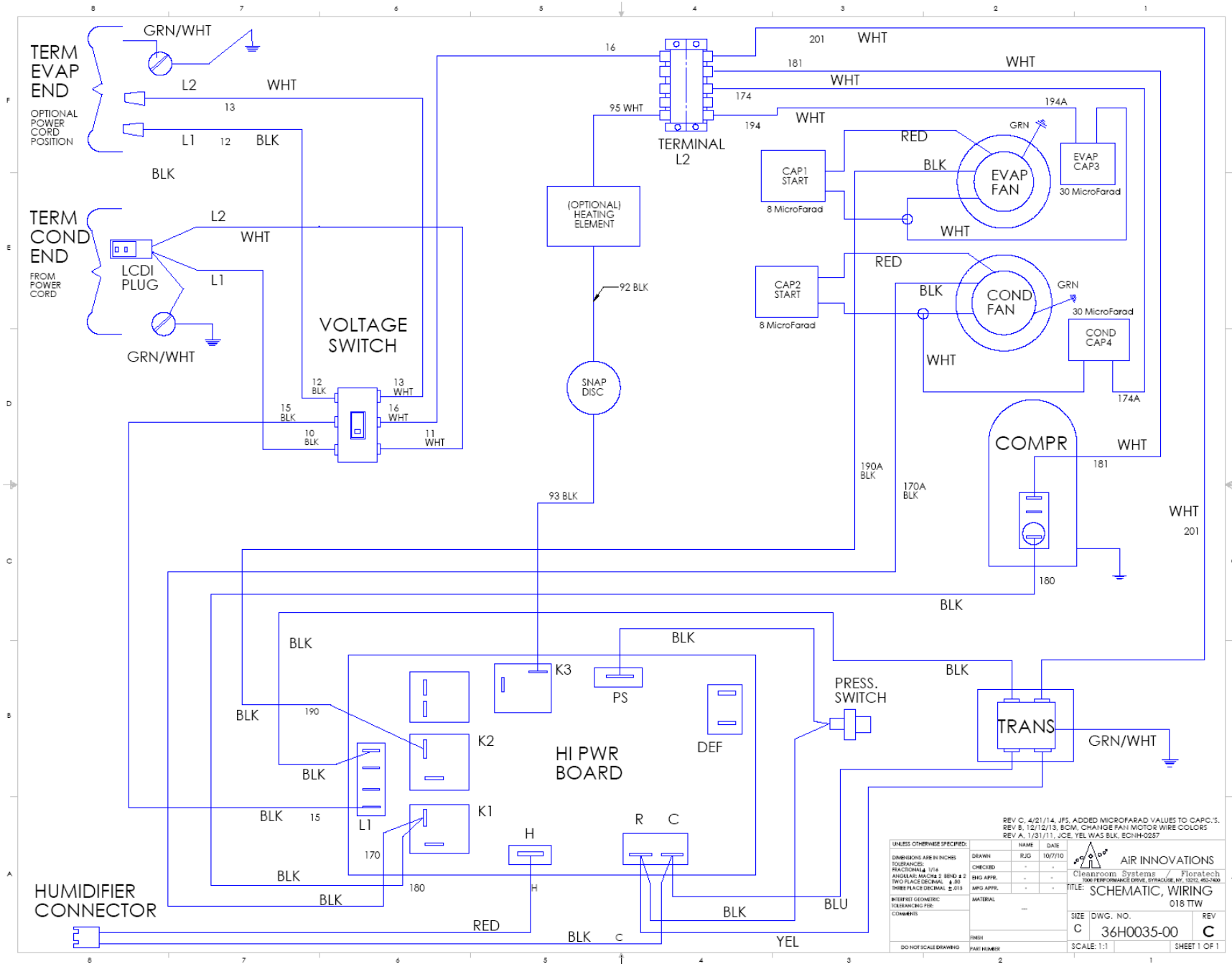

REV C, 4/21/14, JFS, ADDED MICROFARAD VALUES TO CAPC.1.
 REV B, 12/12/13, BCM, CHANGE FAN MOTOR WIRE COLORS
 REV A, 1/31/11, JCE, YEL WAS BLK, ECHN-0257

UNLESS OTHERWISE SPECIFIED:	NAME	DATE
DIMENSIONS ARE IN INCHES	DRAWN	RJG 10/7/10
TOLERANCES:	CHECKED	- -
FRACTIONAL 1/16	ENG APPR.	- -
ANGULAR MATCH 2 BEND 2	MFG APPR.	- -
TWO PLACE DECIMAL 0.00		
THREE PLACE DECIMAL 0.015		

INTERPRET GEOMETRIC TOLERANCING PER: COMMENTS:

AIR INNOVATIONS
 Cleanroom Systems / Floratech
 100% PERFORMANCE DRIVE, SPRINGFIELD, MO, 65714-0000
 TITLE: SCHEMATIC, WIRING
 018 TTW

SIZE DWG. NO. C 36H0035-00
 REV C

DO NOT SCALE DRAWING PART NUMBER SCALE: 1:1 SHEET 1 OF 1

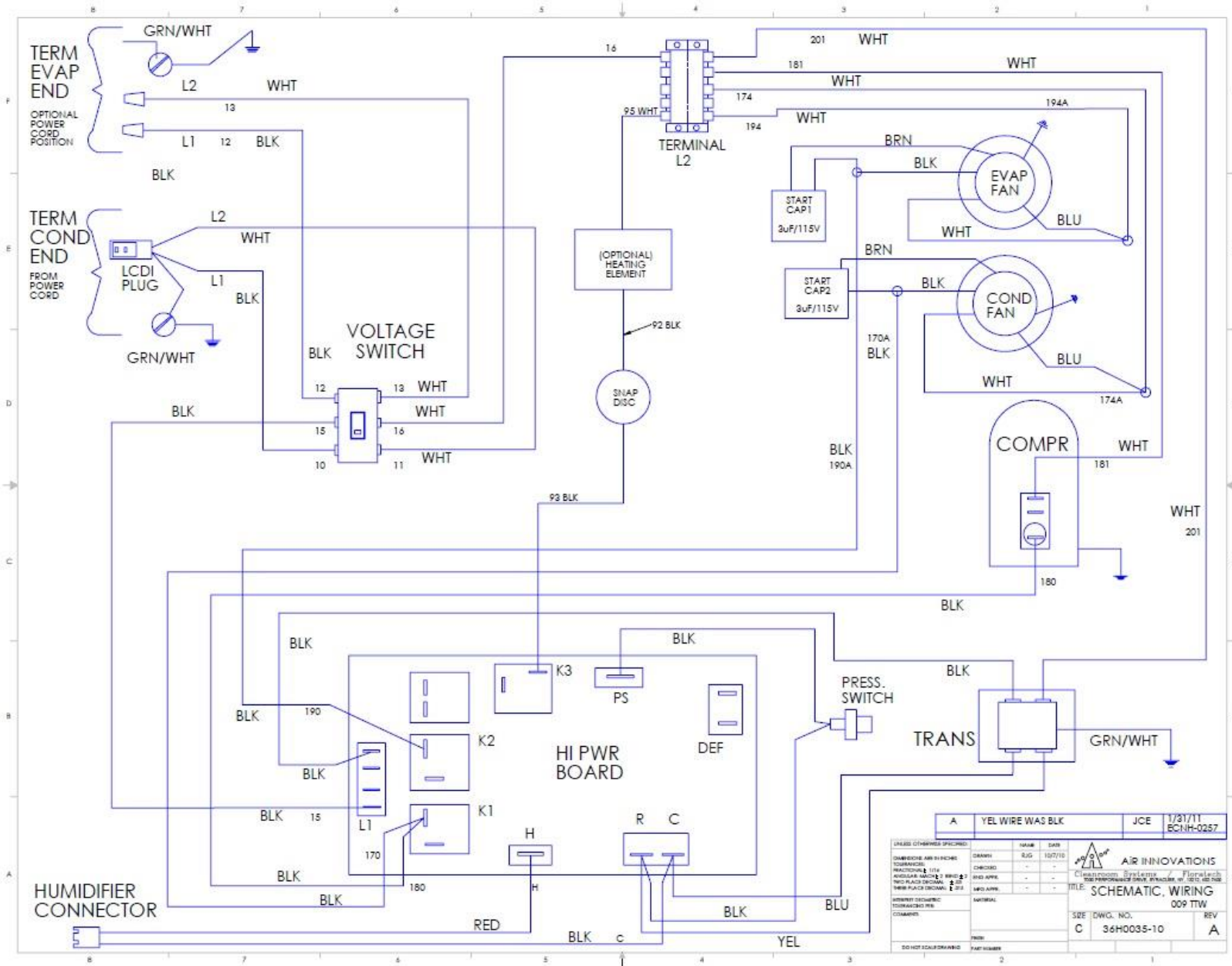

WG25

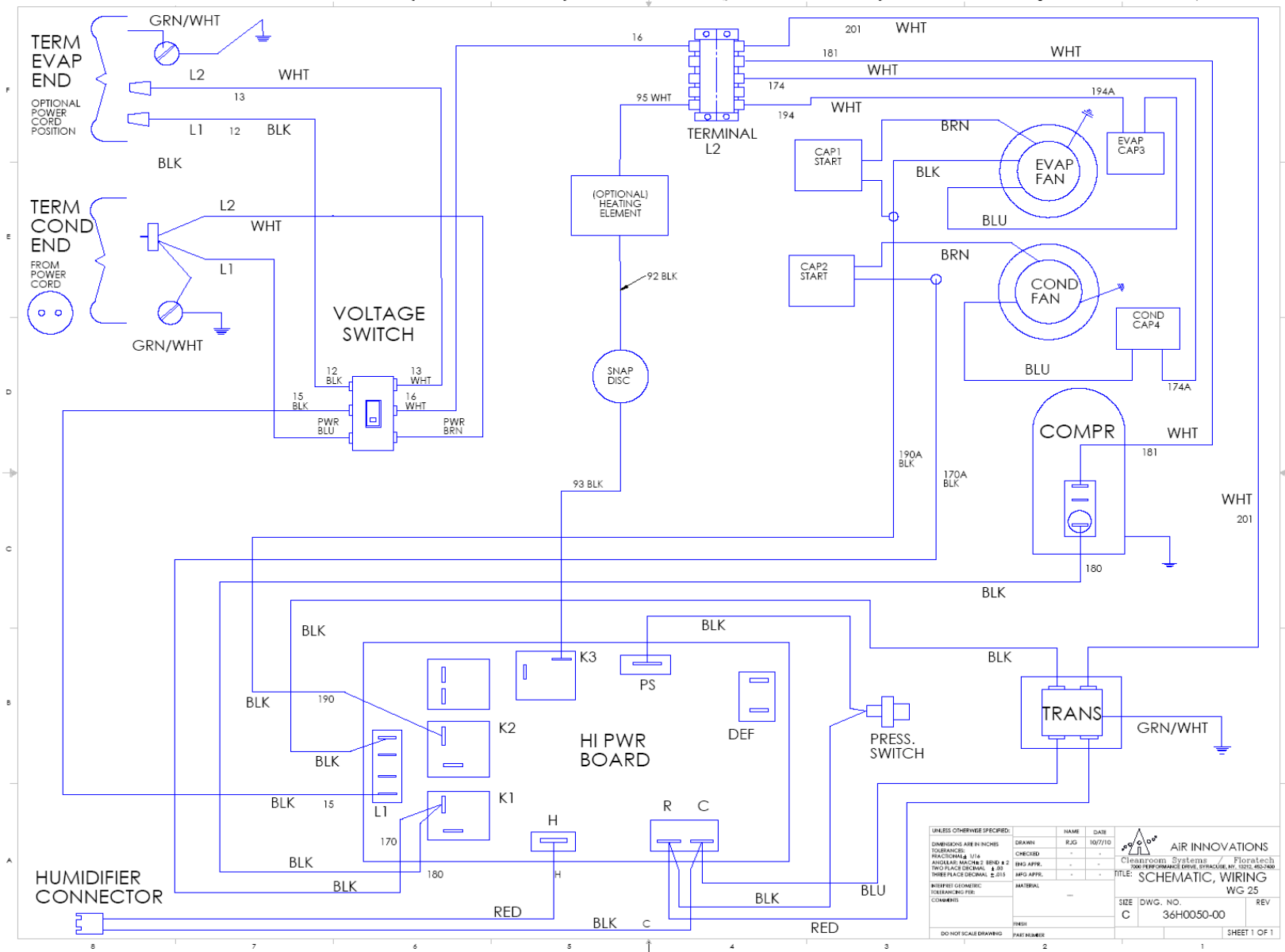

UNLESS OTHERWISE SPECIFIED:		NAME	DATE
DIMENSIONS ARE IN INCHES		RJG	10/7/10
TOLERANCES:		CHECKED	-
FRACTIONS & 1/16		ENG APPR	-
ANGLES MATCH: MIN 4 2		DATE	-
TWO PLACE DECIMAL & 0.01		MFG APPR	-
THREE PLACE DECIMAL & 0.001		MATERIAL	-
INTEGRITY GEOMETRIC		FINISH	-
TOLERANCING PER:		DO NOT SCALE DRAWING	PART NUMBER
COMMENTS:		SIZE	DWG. NO.
		C	36H0050-00
		REV	
			SHEET 1 OF 1

WG15

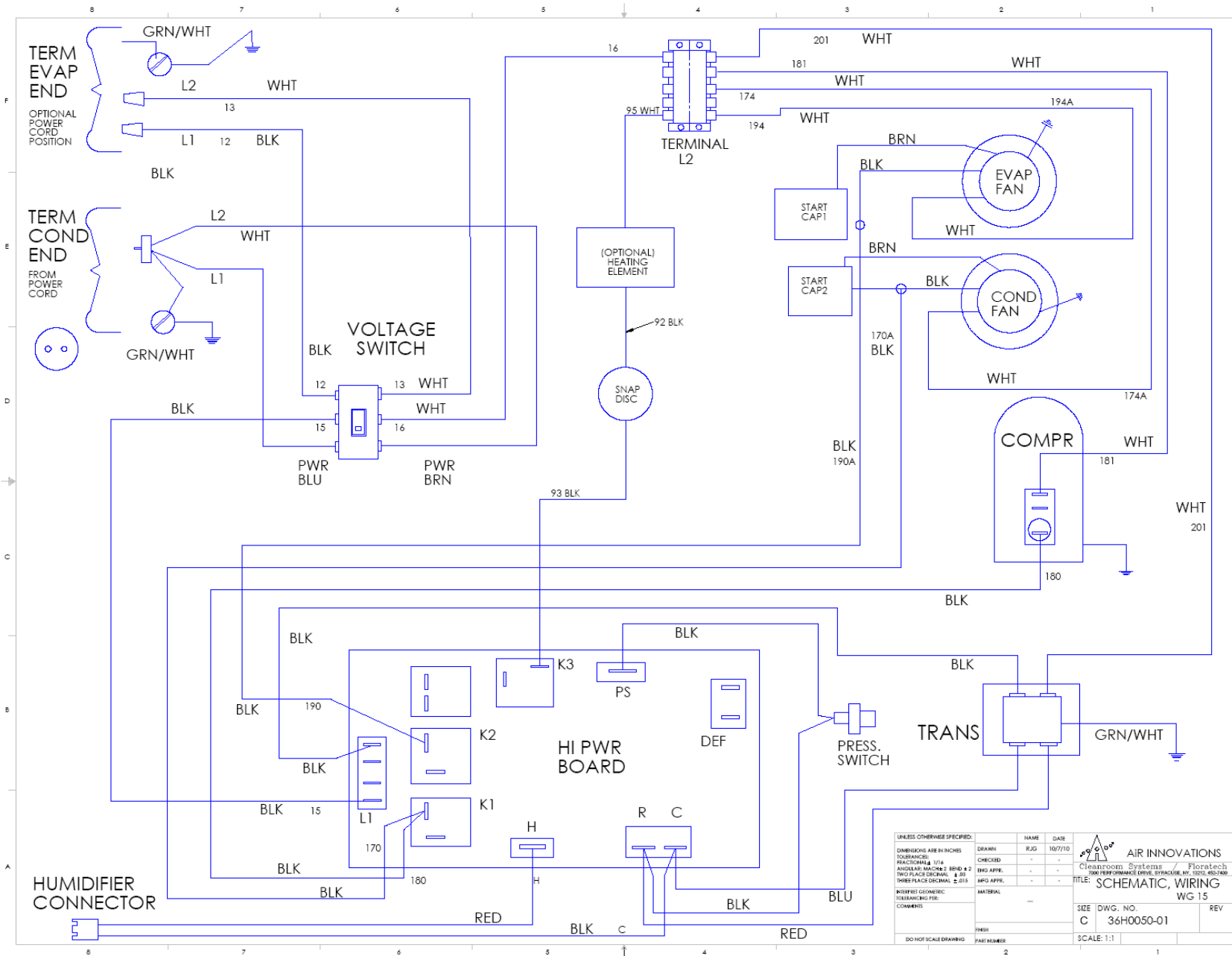

UNLESS OTHERWISE SPECIFIED:		NAME	DATE
DIMENSIONS ARE IN INCHES		DRWN	R/JG 10/7/10
TOLERANCES		CHECKED	- - -
FRACTIONAL 1/16		ENG APPR.	- - -
DECIMAL .0005 & .001		APPROV.	- - -
HOLE POSITION .005		MATERIAL	- - -
HOLE DIA .001		CONDENS	- - -
HOLE DRILL .001		FINISH	- - -
HOLE REAM .001		DO NOT SCALE DRAWING	PAPER NUMBER

AIR INNOVATIONS		SIZE	DWG. NO.	REV
Cleanroom Systems / Floratech		C	36H0050-01	
700 PERFORMANCE DRIVE, SYRACUSE, NY 13212-4627		SCALE	1:1	
TITLE: SCHEMATIC, WIRING				
WG 15				

Safety

The following is suggested before installing or maintaining the Wine Guardian System:

- 1) Read these instructions
- 2) Keep these instructions
- 3) Heed all warnings
- 4) Follow all instructions

Safety Message Conventions

Safety messages contained in this manual, DANGER, WARNING, and CAUTION are bold and highlighted in red for quick identification.

Danger

A **DANGER** message indicates an imminently hazardous situation which, if not avoided, results in death or serious injury. Messages identified by the word **DANGER** are used sparingly and only for those situations presenting the most serious hazards.



HIGH VOLTAGE - RISK OF SERIOUS INJURY OR DEATH
High voltages are present in the cabinets
TURN OFF ALL POWER BEFORE OPENING PANELS
USE THE LOCKOUT/TAGOUT PROCEDURE

Warning

A **WARNING** message indicates a potentially hazardous situation which, if not avoided, could result in death or serious injury.

Following is a typical example of a **WARNING** message as it could appear in the manual:



RISK OF PERSONAL INJURY OR DAMAGE TO EQUIPMENT Modification to the equipment may cause injury.

Caution

A **CAUTION** message indicates a potentially hazardous situation which, if not avoided, could result in minor or moderate injury. It may also be used to alert against unsafe practices.

Following is a typical example of a **CAUTION** message as it could appear in the manual:



RISK OF PERSONAL INJURY OR DAMAGE TO EQUIPMENT
Improper installation may result in the equipment malfunctioning and a safety hazard. Read all of the installation instructions before installing the Wine Guardian.

Lockout/Tagout Procedure

- 1) Turn the system to off at the local interface controller (the display will indicate the system is off).
- 2) Unplug the unit from the electrical outlet and cover the outlet to prevent accidentally plugging in the system.

Safety Considerations

The equipment covered by this manual is designed for safe and reliable operation when installed and operated within its designed specifications. To avoid personal injury or damage to equipment or property when installing or operating this equipment, it is essential that qualified, experienced personnel perform these functions using good judgment and safe practices. See the following cautionary statements.

Installation and maintenance of this equipment is to be performed only by qualified personnel who are familiar with local codes and regulations, and are experienced with this type of equipment.

Safety Hazards

Exposure to safety hazards is limited to maintenance personnel working in and around the system. When performing maintenance, always use the Lockout/Tagout procedure, which is described in this chapter. Observe the maintenance safety guidelines in the Wine Guardian manual.

IMPORTANT
The equipment described in this manual uses electricity. When using this equipment, be sure to follow the safety procedures outlined in the Wine Guardian manual.

Electrical Hazards

Working on the equipment may involve exposure to dangerously high voltage. Make sure you are aware of the level of electrical hazard when working on the system. Observe all electrical warning labels on the system.

Electrical Shock Hazards

All power must be disconnected prior to installation and servicing this equipment. More than one source of power may be present. Disconnect all power sources to avoid electrocution or shock injuries.

Hot Parts Hazards

Electric Resistance heating elements (if equipped) must be disconnected prior to servicing. Electric heaters may start automatically, disconnect all power and control circuits prior to servicing the system to avoid burns.

Moving Parts Hazards

The Motor and Blower must be disconnected prior to opening access panels. The motor can start automatically. Disconnect all power and control circuits prior to servicing to avoid serious injuries or possible dismemberment.

The fans are free-wheeling after the power is disconnected. Allow the fans to stop completely before servicing the system to avoid cuts or dismemberment.

Rotating Fan Blades are present in the Wine Guardian system. Sticking a hand into an exposed fan while under power could result in serious injury. Be sure to use the Lockout/Tagout procedure when working in this area or remove the power cord.

Equipment Safety Interlocks

There are no electrical safety lockouts installed within the system. The power cord attached to the control box must be disconnected from the power sources prior to working on any part of the electrical system.

On/Off Switch

To shut down all high volt power internally, the power cord must be removed from power outlet.

Energy Type

Voltage

Hazard.....	Electrocution, electrical burns and shock
60Hz Magnitude	120 Vac and 230 Vac, 1 phase, 60 cycles
50Hz Magnitude	220/240 Vac, 1 phase, 50 cycles
Control Method.....	Disconnect power cord and On/Off Switch



- **Never** reach into the system while the fan is running.
- **Avoid** risk of fire or electric shock. **Do not** expose the system to **rain** or **moisture**.



- All supports for the system **must** be capable of safely supporting the equipment's weight and any additional live or dead loads encountered.
- All supports for the system **must** be designed to meet applicable local codes and ordinances.
- **Do not** remove access panels until fan impellers have completely stopped. Pressure developed by moving impellers can cause excessive force against the access panels.
- Fan impellers continue to turn (free-wheel) after the power is shut off.



- **Do not** block any supply or return air opening. Install in accordance with the instructions in the Wine Guardian manual.

- **Protect the power cord** from being walked on or pinched, particularly at the outlet plug, convenience receptacles, and the point where it exits the system.
- **Only** use attachments/accessories specified by the manufacturer.
- **Always** operate this equipment from a 120Vac, 1 phase **60Hz power sources only. For 50Hz equipment 220/240Vac, 1 phase 50Hz power sources only.**
- **Always ground the outlet** to provide adequate protections against voltage surges and built-up static charges (see Section 810 of the National Electric Code).
- **Refer all servicing to qualified service personnel.** Servicing is required when the system has been damaged in any way, such as:
 - ✓ Power supply cord or plug is damaged
 - ✓ Liquid has been spilled or objects have fallen into the system
 - ✓ The system has been exposed to rain or moisture
 - ✓ The system does not operate normally
 - ✓ The system has been dropped

Installation

 **CAUTION** 
SHARP EDGES
RISK OF SERIOUS INJURY

Sharp edges are present inside the Wine Guardian system.

Pre-installation Test

Test the system before installing it to check for non-visible shipping damage.

To test the system:

- ✓ Set the system on the floor or a sturdy level surface
- ✓ Plug in the system
- ✓ Press the on/off switch, control illuminates. This indicates the system has power.
- ✓ **The built in timer prevents short cycling and keeps the system from turning on right away.** The system comes on and runs as long as the temperature of the space is above the thermostat set point. After several minutes, cold air comes out of the system from the evaporator section side and hot air comes from the condenser section. Listen for any unusual noise or vibration.

Air Flow Illustration





WARNING



RISK OF PERSONAL INJURY OR DAMAGE TO EQUIPMENT

Modification to the equipment may cause injury or damage to the equipment



DANGER



- ✓ This equipment is heavy. Place the unit on the floor or on a level and stable surface that can support the full weight of the unit.
- ✓ Do not modify the equipment, it may cause damage to the equipment and voids the warranty.
- ✓ Never place anything on top of the unit.
- ✓ Never block or cover any of the openings or outlets to the unit.
- ✓ Never allow anything to rest on or roll over the power cord.
- ✓ Never place the unit where the power cord is subject to wear or abuse.
- ✓ Do not use extension cords.
- ✓ Never overload wall outlets.
- ✓ Do not remove or open any cover unless the unit is turned off and the power cord is plugged in.
- ✓ Use only dedicated power outlet boxes of the correct capacity and configuration for the unit model.



CAUTION



RISK OF PERSONAL INJURY OR DAMAGE TO EQUIPMENT

Improper installation may result in the equipment malfunctioning and a safety hazard. Read all of the installation instructions before installing the Wine Guardian unit

Planning the Installation

Tools required



Drill/Phillips head



Level



Stud finder



Tape measure



Square



Drywall screws



Urethane caulk



Hand saw



Drywall saw



Heavy duty Snap knife

- ✓ Where to locate the unit? *It can be mounted flush with the racking or flush with the wall on the wine cellar side.*
- ✓ How to mount the unit? *A mounting EasyMount™ kit is supplied.*
- ✓ Locate the electrical power outlet close to the unit, in cellar or out. **Do not use an extension cord!**
- ✓ Factory supplied power cord on condenser side of the unit. *It is preferred to be on the condenser side of the unit, the cord can be moved to accommodate wine cellar side if need be.*
- ✓ Does the condenser heat exhaust need to be ducted away? *An optional kit is available.*
- ✓ Where to locate the thermostat, if remote interface control is ordered? *Thermostat should be located midpoint on a wall within the wine cellar and provide sufficient access and exposure to airflow.*
- ✓ How to install the drain line. *Run to an open floor drain, container, or condensate pump.*
- ✓ Are all the parts here to complete the installation? *Installation sleeve, gasket, sealant fasteners*

Performing a Pre-installation Check

- ✓ Check for the properly sized breaker as dictated by the system rating plate data.
- ✓ Is the cellar built with adequate insulation and vapor barriers?

Locating the System

Wine Guardian systems are typically installed at the user's eye level for ease of operation. The Through-the-Wall system discharges warm air from its condenser end so this should be considered when determining the location for the system. Locating the system adjacent to a mechanical room or in close proximity to an exterior wall may be required if ducting the warm condenser air is being considered. The warmer condenser air can be ducted up to 15 feet away (4.5 meters). Be sure to install wire nuts onto the black and white wire leads at the condenser end, once the cord is removed.



Power Cord Location







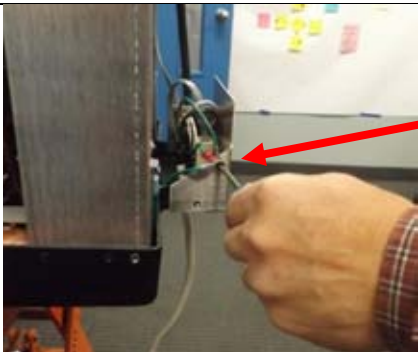
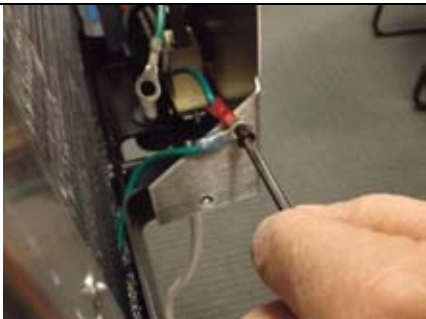

The power cord is factory wired on the condenser side of the system. If you require the cord on the wine cellar side for plugging into an available outlet, this can be accomplished by removing the 3-wire leads (ground included) and moving the cord to the opposite side control bracket and wire nutting the black, white and green wires to the factory supplied leads. The wires must have the terminations cut off and stripped first.

You must then move the red voltage switch in the opposite direction to move the internal power from the condenser side to the wine cellar side. See the steps below for relocating the power cord.

Relocating the power cord

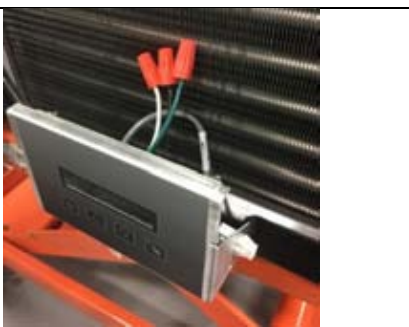
	<p>1. Remove Face Plates from both ends of unit by removing two screws at the base of each cover. Pull each cover down and away from unit.</p>
	<p>2. At the condenser end (warm air side) of the unit unscrew the ground lug from chassis and remove the green wire connected to the power cord as shown.</p>
	<p>3. Re-attach the ground lug onto the chassis and ensure the other two green ground wires are secure and attached back onto the chassis as shown.</p>
	<p>4. Use pliers or flat blade screw driver to push in the tab on the side of the grommet that holds the power cord within the chassis bracket. Pull down on power cord to release from bracket. Power cord can be rotated for easier access to tab.</p>

		<p>5. Disconnect the black and white wires from the power control switch at the back of the bracket as shown.</p>
		<p>6. Cut and strip the Black, White and Green wires at the end of the power cord.</p>
	<p>7. At the evaporator side (wine room side) of the unit feed the Black, White and Green wires from the power cord up through the hole in the bottom of the bracket until grommet snaps into place.</p>	
	<p>8. At the wine room side of the unit, attach each power cord wire to their respective chassis wire. i.e. white to white, black to black and green to green. Use wire nuts supplied on chassis wires to complete the installation.</p>	
	<p>9. At the condenser end of the unit (warm air side) slide the power control switch to the opposite position to move power from the condenser end to the wine room end.</p> <p>10. Reinstall face plates at both ends of the unit.</p>	

Grilles

Factory supplied and installed for proper air intake and discharge for optimal system performance.

Mounting the System

Follow the steps below for installation of the Wine Guardian Through-the-Wall unit.

Step 1



Find wall stud locations. If both wine cellar side and finished basement side of walls have drywall already installed it is important to locate the wall studs in the area chosen to mount the Through-the-Wall system. Use of any high-quality stud finder is recommended for locating the center and edges of the wall studs on the wine cellar wall. Once located, the stud edges should be clearly marked prior to following Step 2 below.

Step 2



Preparing wall penetration for Installation Sleeve. Mark the penetration dimensions on the wall (wine cellar and finished basement side) at the desired mounting location for the Wine Guardian Through-the-Wall unit. Keep in mind the ideal height should be at eye level to the user. The unit controls should be reachable upon installation completion. The wall penetration should be no more than 14-1/2" wide by 16-1/4" high (36.83cm wide by 41.27cm high) stud-to-stud dimension so modifying stud locations is not required.



RISK OF PERSONAL INJURY OR DAMAGE TO EQUIPMENT

Ensure that the area chosen does not have electrical or plumbing interference within the wall or along the outside of the wall. Failure to do so could cause property damage or personal injury. If the wall does include electrical wiring or plumbing DO NOT CONTINUE. Contact a qualified electrician or plumber to relocate these services or choose an alternate location for mounting the WG system.

Step 3



Slide the EasyMount™ sleeve through the wall penetration so that the flanged area of the sleeve sits flush with the surface of the wall. Ensure the EasyMount™ sleeve is level and plumb prior to fastening to the existing studs.

New Design EasyMount™ Sleeve

The new design EasyMount sleeve is fastened through the four (4) holes located on either side as shown on left.

IMPORTANT

The Installation Sleeve must be installed level within the wall opening to provide proper operation of the Wine Guardian system. Failure to do so may result in improper drainage, excessive wear, vibration and noise.

RISK OF PERSONAL INJURY OR DAMAGE TO EQUIPMENT

Flange side of the sleeve must be mounted on side of wall you intend to have the WG flush mounted.

Step 4



Insert screws into upper pre-drilled hole on both sides of sleeve, continue to lower set of holes. Ensure screws are flush with wall sleeve. Do not over tighten.

Step 5



Slide the Wine Guardian Through-the-Wall system through the EasyMount™ sleeve to the desired depth. Please note the Through-the-Wall system must be slid so that the power cord side is last, not first, to enter the sleeve. Do not slide the system past the desired flush mounting point.

Step 6



Seal joint between EasyMount™ sleeve and Wine Guardian system on the flange side of system with a latex caulk to ensure a tight seal and prevent the system from horizontal movement. After caulking add the kit supplied self-adhesive insulate strips tight to the chassis and cover the wall sleeve flanges to prevent possible sweating.

Installing the Condensate Overflow

Condensate generation is a natural by-product of air conditioning systems. The Wine Guardian cooling coils are designed with the understanding that optimal wine cellar humidity levels are between 55% RH and 60% RH. If the vapor barrier of the wine cellar is poorly constructed or excessive moisture is in the basement or surrounding areas, then the cooling coil may generate excessive amounts of moisture. The condensate will appear in the form of water at the cooling coil drain pan and eventually will travel to the condensate removal system located below the compressor. The Wine Guardian system features an auxiliary drainport connection located at the condenser end of the system directly below the plastic face plate



Installing the Drain Line

Connect the clear plastic tube (included) to the drainport. The drain line must extend from the system to an external drain or disposal site. Do not use drain tubing any smaller than ½ inch inside dimension on the system.

If no floor drain is available, use a bucket or condensate pump. Do not extend the drain below the rim of the bucket. Empty the bucket periodically.

Allow enough height for the drain line to function properly. If draining into a nearby sink, the system must be elevated higher than the rim of the sink for the water to drain by gravity. Install with a ¼ inch per linear foot of pitch. See Accessories and Optional Equipment on page 10 for information about the condensate pump.

- If you consistently have water present from the overflow port you will need to permanently pipe the drain to an open floor drain, sink, or condensate pump.
- If you experience NO water you may wish to remove the plastic drain hose and install the plastic drain port cover (included).

Priming the Drain Trap

The internal drain trap primes itself automatically once the unit has run for a period of time and after the system cycles off. This is confirmed by water dripping from the drain.

Wiring the System for Power



WARNING

ELECTRICAL SHOCK HAZARD

The electrical outlet and wiring installation must meet the national and local building codes.

DO:

- ✓ Match the electrical outlet to the plug provided on the Wine Guardian.
- ✓ Provide dedicated circuit and wiring for the system.
- ✓ Match the wiring and breaker size to the rated load as shown on the serial plate and in this guide. See sample serial plate illustration below.

Model# TTW018		Serial# 10B14661
Electrical	115/160	Electric Heat Amps (Opt.)
Locked Rotor Amps	27.5	
Compressor RLA	3.35	
Condenser Fan Amps	0.4	Min. Circuit Amps (w/o opt.) 5
Evaporator Fan Amps	0.4	Refrigerant R-134-A
Condensate Heater	N/A	System Charge 12oz
Total Unit Amps (w/o opt.)	4.15	Test Pressure 278psi
Air Innovations, 7000 Performance Drive, North Syracuse, New York 13212		
Ph: 600-535-3295 * 315-452-7400 * Fax: 315-452-7420		

DO NOT:

1. DO NOT MODIFY THE PLUGS IN ANY WAY!
2. Do not use extension cords.

IMPORTANT

The electrical power supply must be 115-volt AC 1 phase 60 cycle (240-volt AC 1 phase 50 cycle), depending on the model of the system, and cannot vary more than +/- 4% or damage may occur to the unit.



Plug the system into the wall outlet. Gently pull on the plug to make sure it is tight.

Electrical Plug Configuration 60Hz Models Only



To comply with the UL STD 484 this system contains a factory supplied LCDI (leakage current detection interrupter) power cord, which specifies that single phase portable air conditioning units contain a protection device to reduce the risk of an arc fault occurring in the power cord. These provide a reliable way to prevent the risk of fire due to a damaged power cord. They feature electronic detection to automatically cut off power to the unit when a current leakage condition is detected in the systems power cord.

Electrical Plug Configuration 50Hz Models Only



This is the configuration of the factory supplied plug for European applications. Alterations to this plug for alternative power sources would require factory approval. LCDI (leakage current detection interrupter) power cord, which specifies that single phase portable air conditioning units contain a protection device to reduce the risk of an arc fault occurring in the power cord. These provide a reliable way to prevent the risk of fire due to a damaged power cord.

They feature electronic detection to automatically cut off power to the unit when a current leakage condition is detected in the systems power cord.

Once power is shut off, the device will not be able to be reset until the unsafe current leakage situation is resolve. Power is restored by the “reset” button on the cord’s power head.

Installing the Thermostat and Communication Cable



Local Interface Controller

The Wine Guardian Local Interface Controller is a combination temperature and humidity controller with single stage cooling, heating and humidifier control. Each Wine Guardian Through-the-Wall unit is supplied with a Local Interface Controller as an integral component of its assembly. It is installed at the factory and tested prior to shipment.

In most applications, the Local Interface Controller is adequate for proper wine cellar monitoring and control.

However, sometimes multiple points of sensing and control are ideal, especially for odd shaped rooms.



Optional Remote Interface

Wine Guardian Remote Sensors offer the ability to sense a maximum of three locations and control to their average condition.

Wine Guardian also offers the option of monitoring the wine cellar conditions from outside of the wine cellar or from another room in the home or building, through the use of the Remote Interface Controller. **(Optimal temperature 55 Degrees F or 13 Degrees C)**

Mounting the Optional Remote Interface Controller



Fig. 1

1. Disconnect the communication cable from the back of Remote Interface Controller. (Fig. 1)
 - a). Install the communication cable within the wall and/or ceiling structure of the wine cellar to the desired controller mounting location.
 - b). Mount the remote interface controller on a solid surface away from doors, corners, air outlets, drafts or heat generating equipment. Do not mount the Remote Interface Controller directly on an outside wall or wall adjacent to a boiler room



Fig. 2



Fig. 3



Fig. 4



Fig. 5



Fig. 6

2. Remove the back plate of the controller and mark the mounting points at the desired location. (Fig. 2)

a). Mark the location of the communication cable connection as this area will require sufficient clearance for instance, a 1½” (3.8mm) hole in the wall for flush mounting of the back plate. (Fig. 3)

3. Drill two 1/8” (2mm) holes and insert anchors (provided) within the mounting surface. Anchors may not be required if securing to a wall stud or racking system.

4. Plug in the communication cable to the back of the Remote Interface Controller backing plate. (Fig. 4)

a). Attach backing plate to wall using the two screws provided with the system. (Fig. 5)

5. Re-install plastic face plate on to backing plate. (Fig.6)

Installation of the Optional Wine Guardian Remote Sensor



The Remote Sensor is a combination temperature and humidity sensor only. It is designed to be mounted within the wine cellar and can be used in combination with Local Interface Controller or the Remote Interface Controller and up to two additional Remote Sensors to control multiple areas within the wine cellar.

Note: The Remote Sensor and Remote Interface Controller are now only available in black

Mounting the Remote Sensor



Fig.1

1. Disconnect the communication cable from the back the remote sensor. Install the communication cable within the wall and/or ceiling structure of the wine cellar to the desired controller mounting location.

Important

A splitter device has been supplied within the Remote Sensor kit. The splitter device must be mounted at the WG unit. DO NOT mount the splitter device at the back of the Remote Interface Controller or to the back of the Remote Sensor as this WILL cause component or system damage.



Fig, 2

2. Mount the Remote Sensor on a solid surface away from doors, corners, air outlets, drafts or heat generating equipment. Do not mount the Remote Sensor directly on an outside wall or wall adjacent to a boiler room. Use a piece of foam insulation behind the sensor to insulate it from a hot or cold surface. The recommended height is 4 to 5 feet (1.2 to 1.5 meters) above the finished floor.
3. Remove the sensor cover plate by removing the two allen head screws at the top of the cover using the allen head wrench provided in the kit. (Fig.2) Mark the mounting points at the desired location within the wine cellar. Also mark the location of the communication cable connection as this area will require sufficient clearance, for instance 1½” (3.8cm) hole in the wall for flush mounting of the sensor plate.

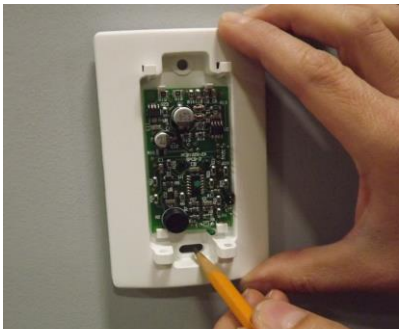

Fig. 3



Fig.4



Fig. 5



Fig. 6

4. Drill two 1/8" (3.15mm) holes and insert anchors (provided) within the mounting surface. Anchors may not be required if securing to a wall stud or racking system. (Fig. 3)

5. Plug in the communication cable to the back of the Remote Sensor and attach to the wall using the two screws provided in the kit. (Fig. 4)

6. Plug the Remote Sensor cables into the splitter device at the WG unit along with the communication cable for the Remote Interface Controller. (Fig. 5)

NOTE: If using multiple Remote Sensors in one wine room, continue to mount the remaining sensors before installation of the sensor cover plates. When multiple sensors are used, the sensor jumper position must be adjusted in order for proper averaging of temperature and humidity readings. See page 35 for jumper set up.

Joining Communication Cable

Important

Wine Guardian cooling systems are supplied with 50 feet (15 meters) of 6 wire, Cat 3 twisted pair communication cable with RJ11 type connectors. Caution must be taken when connecting two lengths of communication cable (splicing) to ensure uniform wire color before and after splice. An RJ11 Modular 6 wire STRAIGHT THROUGH type coupler is the ONLY coupler approved for splicing Wine Guardian twisted pair communication cable.

Changing Jumper Positions (Averaging readings from Remote Sensor)



Jumper position 1



Jumper position 2



Jumper position 3

If using multiple Remote Temperature/Humidity sensors in your application, refer to the photos showing the need to change the jumper locations internal to the control board on each remote sensor (up to 3 maximum).

For the control to average all the sensors utilized (if more than one), the jumper must be in different positions on the pins.

There are three pin settings. To access the jumper:





1. Remove the two-set screws holding on the plastic cover. This procedure allows the control to go to each remote sensor in sequence to average. Failure to perform this procedure will result in the system reading only one sensor and not the average of multiple sensors.

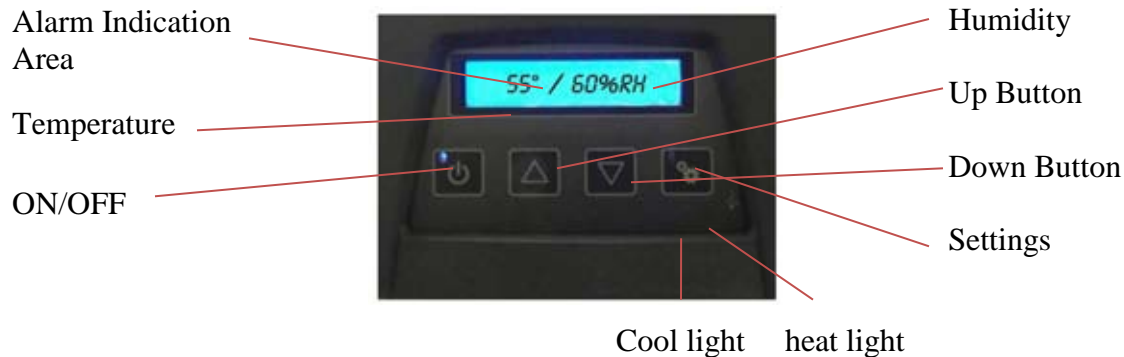





NOTE: If multiple sensors control the Wine Guardian unit, change factory default in configuration setting 10 to “averaging.” Obtain access code from Wine Guardian service department to use in configuration 8 to reach configuration 10.

Standard Controller Functions







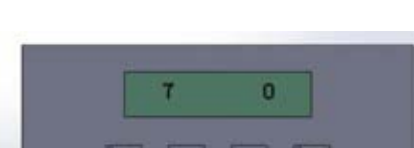

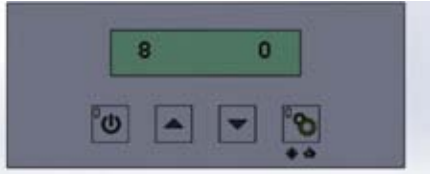

Settings – Press and hold the “Mode” button for five (5) seconds to access the following settings.

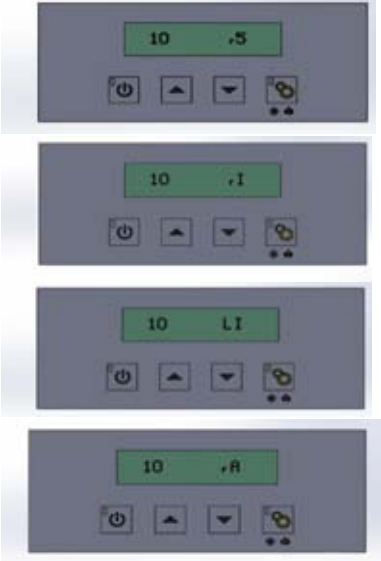



<i>How to:</i>		
Turn system on/off		<ul style="list-style-type: none"> • Press the On/Off” button once. • NOTE: There is a five- minute time delay before the system turns on or turns off. • *** Green LED lit when unit is on
Change Temperature		<ul style="list-style-type: none"> • Press the “Up” arrow once. The display will show the existing temperature setpoint along with the “Setting” (Auto, Cool or Heat). • Press the “Up” or “Down” arrow buttons to adjust the temperature to the desired setpoint.
Change Humidity		<ul style="list-style-type: none"> • Press the “Up Arrow” once. This display will show the existing temperature setpoint. • Press the “Settings” button once to display the Humidity setpoint. • Press the “Up” or “Down” arrows to adjust the humidity to the desired setpoint. <p>NOTE: A Wine Guardian humidifier must be installed and setting six set to “2” before the controller will display and let you change percent humidity.</p>
Change Setting -- Cooling/Heating/Auto		<ul style="list-style-type: none"> • Press the “Settings” button once to display the “Set Mode” function. The existing mode will display below the words “Set Mode.” • Press the “Settings” button again to scroll through settings for “Cool” (cooling only), “Heat” (heating only) or “Auto” (cool and heat). •

<p>Deg F or Deg C</p>		<p>Setting 1</p> <ul style="list-style-type: none"> Press the “Down” arrow to change temperature from Deg F to Deg C. (50Hz models default is C) Press the “Up” arrow to change temperature from Deg C to Deg F.
<p>Low temperature alarm set point</p>		<p>Setting 2</p> <ul style="list-style-type: none"> Press “Settings” button to advance to Setting 2. Press the “Up” or “Down” arrow buttons to adjust to the desired set point. Factory default is 50 Deg. F.(10 Deg C)
<p>High temperature alarm set point</p>		<p>Setting 3</p> <ul style="list-style-type: none"> Press “Settings” button to advance to Setting 3. Press the “Up” or “Down” arrow buttons to adjust to the desired set point. Factory default is 65 Deg F. (18 Deg C)
<p>Low humidity alarm set point</p>		<p>Setting 4</p> <ul style="list-style-type: none"> Press “Settings” button to advance to Setting 4. Press the “Up” or “Down” arrow buttons to adjust to the desired set point. Factory default is 5%.
<p>High humidity alarm set point</p>		<p>Setting 5</p> <ul style="list-style-type: none"> Press “Settings” button to advance to Setting 5. Press the “Up” or “Down” arrow buttons to adjust to the desired set point. Factory default is 95%.
<p>Add or remove humidifier</p>		<p>Setting 6</p> <ul style="list-style-type: none"> Press “Settings” button to advance to Setting 6. Press the “Up” or “Down” arrow buttons to adjust to the desired set point. Factory default is zero (0). <p>Zero (0) = No humidifier One (1) = Integral Wine Guardian mounted (internal) Two (2) = Stand-alone remote mounted humidifier</p>
<p>Fan AUTO or ON</p>		<p>Setting 7</p> <ul style="list-style-type: none"> Press “Settings” button to advance to Setting 7. Press the “Up” or “Down” arrow buttons to adjust number to the desired set point. Factory default is zero (0). <p>Zero (0) = Auto – fan only turns on when there is a call for cooling or heating or humidity One (1) = Fan On – fan remains on continuously</p>



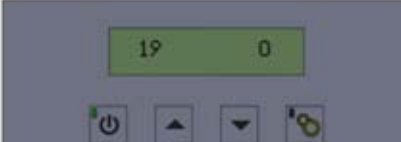

Advanced Settings

<p>Advanced Settings-</p>		<p>Setting 8</p> <ul style="list-style-type: none"> • Press “Settings” button to advance to Setting 8. • Press the “Up” or “Down” arrow buttons to adjust number to the access code 12. Press “Settings” button to continue onto setting 9 through 19.
<p>Compressor anti-short cycling time</p>		<p>Setting 9</p> <ul style="list-style-type: none"> • Press the “Up” or “Down” arrow buttons to adjust to the desired time in one minute increments. Maximum is 10 minutes, minimum is 0 minutes. <p>Compressor anti-short cycling time is the amount of allowable time between compressor stop and restart. Rapid start/stop of compressors can cause premature failure. Factory default is 5 minutes.</p> <p>WINE GUARDIAN DOES NOT RECOMMEND SETTINGS LOWER THAN FACTORY DEFAULT.</p>
<p>Set up remote sensor or thermostat</p>		<p>Setting 10</p> <ul style="list-style-type: none"> • Press “Settings” button to advance to Setting 10. • Press the “Up” or “Down” arrow buttons to adjust to the desired setting. <ul style="list-style-type: none"> • Remote sensor • Remote interface • Local interface – Through-the-wall unit only (can also be installed as option for TTW) • Averaging – Jumper position within sensors must be adjusted. See page 30.
<p>Enable or disable defrost sensor input</p>		<p>Setting 11</p> <p>Press "Settings" button to advance to Setting 11.</p> <ul style="list-style-type: none"> • Press the “Up” or “Down” arrow buttons to adjust to the desired setpoint • 1 will equal enabled and a 0 (zero) will equal disabled.

<p>Defrost cut in temperature</p>		<p>Setting 12</p> <ul style="list-style-type: none"> • Press "Settings" button to advance to Setting 12. • Press the "Up" or "Down" arrow buttons to adjust to the desired setpoint • This setting will be adjustable from 25 Deg F to 40 Deg F (4 Deg C - 5 Deg C). Default will be 35 Deg F (2 Deg C). <p>There must be at least a 1 Deg F/C difference between defrost cut in and cut out set points</p>
<p>Defrost cut out temperature.</p>		<p>Setting 13</p> <ul style="list-style-type: none"> • Press "Settings" button to advance to Setting 13. • Press the "Up" or "Down" arrow buttons to adjust to the desired setpoint. • This setting will be adjustable from 35 Def F to 50 Deg F (2 Deg C - 10 Deg C). Default will be 40 Deg F (5 Deg C). • There must be a least a 1 Deg F/C difference between defrost cut in and cut out set points. <p>Note: This setpoint must be 1 Deg F/C higher than setting 12.</p> <p>Note: If C is selected and then switched back to F the default cut out will change to 41 Deg F.</p>
<p>Compressor run time setting for defrost.</p>		<p>Setting 14</p> <ul style="list-style-type: none"> • Press "Settings" button to advance to Setting 14. • Press the "Up" or "Down" arrow buttons to adjust to the desired setpoint. • The setting for compressor run time can be adjustable from 1 to 12 hours in 1 hour increments. Default will be 1 hour.
<p>Room sensor calibration</p>		<p>Setting 15</p> <ul style="list-style-type: none"> • Press "Settings" button to advance to Setting 15. • Press the "Up" or "Down" buttons to adjust to the desired setpoint. Maximum setting is +5, minimum setting is -5. Factory default is zero (0). Sensor calibration setpoint changes the actual display reading (temperature only) by the value of this setting. <p>Example: Sensor reading = 55 Deg F (12 Deg C) Setting 15 Set to +4 Display reading = 59 Deg F (15 Deg C)</p>

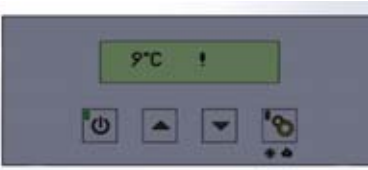
<p>RH% Sensor Calibration</p>		<p>Setting 16 This setting will allow the adjustment of RH% reading by +/-10%. Factory default is 0%RH.</p>
<p>Differential temperature adjustment</p>		<p>Setting 17</p> <ul style="list-style-type: none"> • Press “Settings” button to advance to Setting 17 • Press the “Up” or “Down” buttons to adjust to the desired setpoint. <p>This setting changes the system/compressor; turn on temperature above setpoint. Factory default is set to 1 Deg F. Example: Sensor reading = 55 Deg F (12 Deg C) Setting 17 Set to +3 Deg F System/compressor turns on at 58 Deg F. (14 Deg C)</p>
<p>Deadband setting</p>		<p>Setting 18</p> <ul style="list-style-type: none"> • Press “Settings” button to advance to Setting 17. • Press the “Up” or “Down” buttons to adjust to the desired setpoint. <p>This setting is the minimal allowable temperature difference between heating and cooling setpoints. Maximum is 5 Deg F,(-15 Deg C) minimum is 1 Deg F. Factory default is set to 2 Deg F (-16 Deg C)</p>
<p>Test mode setting</p>		<p>Setting 19</p> <ul style="list-style-type: none"> • Press “Settings” button to advance to Setting 7. • Press the “Up” or “Down” buttons to adjust to the desired setpoint. When set to one the controller will automatically turn on all outputs with the exception of electric heat. Factory default is zero. <p>Zero (0) = Off. One (1) = On</p>
<p>System Selection</p>		<p>Setting 20</p> <ul style="list-style-type: none"> • DO NOT CHANGE

Alarm Codes

<p>High temperature alarm "flashing"</p>		<p>Press the "Up" or "Down" arrow once to change screen from alarm to normal Temperature and Humidity indication. "Hi Temp" will remain on screen until temperature falls below the High Temperature Alarm setpoint (Setting 3).</p>
<p>Low temperature alarm "flashing"</p>		<p>Press the "Up" or "Down" arrow once to change screen from alarm to normal Temperature and Humidity indication. "Lo Temp" will remain on screen until temperature rises above the Low Temperature Alarm set point (Setting 2).</p>
<p>High humidity alarm "flashing"</p>		<p>Press the "Up" or "Down" arrow once to change screen from alarm to normal Temperature and Humidity indication. "Hi Hum" will remain on screen until humidity falls below the High Humidity Alarm setpoint (Setting 5).</p>
<p>Low humidity alarm "flashing"</p>		<p>Press the "Up" or "Down" arrow once to change screen from alarm to normal Temperature and Humidity indication. "Lo Hum" will remain on screen until humidity rises above the Low Humidity Alarm set point (Setting 4).</p>
<p>!1 = High Pressure Switch Fault</p>		<p>THIS ALARM FORCES THE SYSTEM TO SHUT DOWN</p> <ul style="list-style-type: none"> ◦ This alarm forces the system to shut down <p>Press the "Up" or "Down" arrow once to change screen from alarm to normal Temperature and Humidity indication.</p> <p>"!1" will remain on screen until the High Pressure reset switch has been reset. See the trouble shooting guide page 45 for "Instructions to Reset High Pressure Switch"</p>
<p>!2 = CS (Condensate Switch Fault)</p>		<p>THIS ALARM FORCES THE SYSTEM TO SHUT DOWN</p> <ul style="list-style-type: none"> ◦ This alarm forces the system to shut down <p>Press the "Up" or "Down" arrow once to change screen from alarm to normal Temperature and Humidity indication.</p> <p>"!2" will remain on screen until the CS (condensate switch) fault is resolved and reset</p>

Starting-up and Operating the Wine Guardian

Control Settings



The control has been wired and set up in the factory for testing with default settings. It is an electronic digital thermostat for one-stage cooling. No additional adjustments should be necessary except adjusting the cellar temperature to your preference. If additional adjustments or changes are necessary, please refer to the configuration settings section in this manual.

Controller Functions

ON/OFF – The ON/OFF button will be used to turn the system on or off. When set to the off mode the control will not allow any of the outputs to energize effectively locking the system out. It will not allow any outputs to energize until the system is turned on with the ON/OFF button. It should be noted that high voltage will still be present at the main control board when the system is set to off even though the control will not allow it to switch to the outputs.

UP Arrow – The UP arrow will allow the user to increase settings.

DOWN Arrow – The DOWN arrow will allow the user to decrease settings.

SETTINGS – The setting button will be used to select between HEAT, COOL and AUTO MODE, as well as entering the configuration settings. Holding the SETTINGS button for 5 seconds will enter configuration mode. Once in configuration mode the user can adjust settings by pressing the UP or DOWN arrows. Pressing the SETTINGS button once will advance to the next configuration settings. Holding the SETTINGS button for 5 seconds while in configuration mode will store all changes and exit configuration mode.

For cooling operation only: Cooling for **60Hz models** is set at 55°F from the factory and 13°C for **50Hz models**. This can be changed by hitting the UP or DOWN arrow, but please refer to configuration settings # 2 and # 3 for limitations in comparison to the High and Low temperature alarm settings.

For units with optional humidifier controlled by TTW WG: The RH% is factory set at 55%. This can be changed by referring to configurations setting # 6. If no humidifier is attached, the control will read RH%, but will not be controlling it.

Changing fan operation: The default setting from the factory is “AUTO” fan. If desired it can be changed to fan “ON” by accessing configuration setting # 7.

Regulating the Wine Cellar Temperature

To keep the entire wine cellar at the same temperature, set the thermostat to run the supply fan continuously, and not just when there is a call for cooling. Set Fan switch to ON instead of AUTO, by accessing configuration setting # 7.

Changing the Air Flow Direction

The grilles furnished with Wine Guardian are single directional, but the wine cellar airflow can be directed manually by setting the louvers behind the plastic panel to the desired direction. You must first remove the two (2) screws at the bottom of the plastic front panel to gain access to the louvers.



Maintenance



BEFORE PERFORMING MAINTENANCE ON THE SYSTEM, READ AND UNDERSTAND THE SAFETY INFORMATION CONTAINED WITHIN THE SAFETY CHAPTER OF THE WINE GUARDIAN MANUAL.



HIGH VOLTAGE - RISK OF SERIOUS INJURY OR DEATH

High voltages are present in the cabinets. Turn off all power. Use the Lockout/Tagout procedure before removing end panels or cover.



SHARP EDGES RISK OF SERIOUS INJURY

SHARP EDGES ARE PRESENT ON THE FAN WHEELS, HOUSING, INS AND COILS. Maintenance on Wine Guardian system requires working with high voltage and sheet metal with possible sharp edges. Only qualified personnel should perform maintenance. Some tasks require knowledge of mechanical and electrical methods. Make sure you are familiar with all hazards, general safety related procedures, and safety labels on the system



EXPOSURE TO MICROBIAL GROWTH (MOLD) CAN CAUSE SERIOUS HEALTH PROBLEMS

Standing water in drain pans promote microbial growth (mold) that cause unpleasant odors and serious health-related indoor air quality problems. If mold is found, remove it immediately and sanitize that portion of the system.

The Wine Guardian is designed for minimum maintenance. The refrigerant system is hermetically sealed and requires no maintenance. The fans are permanently lubricated and require no maintenance. Some maintenance to the system may be required due to dust or dirt in the air stream.

Maintenance Schedule

Monthly

(Or quarterly depending on experience with individual cellar)

- ✓ Check for noise or vibration.
- ✓ Check for short-cycling of the system – a turning on and off of the compressor unit more than eight (8) times/hour.

Yearly

(In addition to monthly)

- ✓ Check evaporator and condenser coils for dirt – use a vacuum with a brush attachment to clean the coils.
- ✓ Clean condensate pan under the evaporator coil by flushing. Be careful to keep the drain pans clear of any and all debris.
- ✓ Inspect cabinet for corrosion or rusting – clean and paint.
- ✓ Inspect for dirt buildup on or inside the unit. Clean system by vacuuming or wiping it down.
- ✓ Check for loose insulation, fasteners, gaskets or connections.
- ✓ Check the wiring connections and integrity of cords.
- ✓ Examine condenser duct (if option is used) for any cracks or breach.

High Pressure Switch Has Shut the System Down

Every Wine Guardian system has a manual reset high pressure switch in the refrigeration system. This switch shuts the compressor and condenser down if the head pressure in the system is too high. It is intended to protect the compressor. Restricted airflow through the condenser is the most common reason for the pressure to become too high. This can be caused by dust covering the coil or an obstruction blocking the airflow in the duct or grille.

Possible Cause

Head pressure in unit is too high because an obstruction is restricting air flow through the unit.

Solution

Remove the obstruction in the duct or grille or clean the coil. Then restart the system after resetting the high-pressure switch.

Instructions to Reset High Pressure Switch

- ✓ Turn the Wine Guardian system off at the control panel (local or remote interface).
- ✓ Locate the high pressure reset switch which is located within the air outlet section at the condenser side of the system. The switch has a red push button and is accessible by removing the plastic end cover.
- ✓ Locate red push button using a flash light inside the condenser outlet section. Reaching your hand inside or using a long screwdriver, push in the button until it locks into position.
- ✓ Remove the condenser side plastic access faceplate.
- ✓ Push in the button until it locks into position.
- ✓ Place the condenser side plastic panel faceplate back on.
- ✓ Restart the unit at the control panel (local or remote interface).



Alarm Annunciation



When an alarm condition occurs, the control will flash the backlight on the display in addition to annunciating the actual fault on the screen. The user can make the backlight flashing stop by pressing a button on the local user interface. However, the alarm annunciation will not actually clear on the display until the fault is corrected.

Troubleshooting



BEFORE PROCEEDING, READ AND UNDERSTAND THE SAFETY INFORMATION CONTAINED IN THE SAFETY SECTION OF THE WINE GUARDIAN MANUAL.

IMPORTANT

This section is intended as a diagnostic aid only. For detailed repair or parts replacement procedures, contact a qualified service company. Check the following table for some solutions before calling a service technician.

Typical Start-up Problems

<i>Possible Cause</i>	<i>Solution</i>
Incorrect thermostat or humidistat	Check the thermostat and humidistat setup for the application. Read the thermostat troubleshoot guidelines in the Thermostat Installation and Operating Instructions.
Changed settings on the thermostat	A common problem is not waiting long enough for the internal timers to complete their timed delay. Allow 5 minutes for compressor to start.

Unit Does Not Start-up

<i>Thermostat light is off</i> <i>Possible Cause</i>	<i>Solution</i>
Voltage switch not in correct position No power to outlet Unit not plugged in LCDI tripped	Check position of voltage switch Check circuit breaker and wiring Plug in the unit Reset
<i>Thermostat light is on</i> <i>Possible Cause</i>	<i>Solution</i>
Thermostat is not set up properly	Check thermostat set up in the guide

Unit is Operating and Blows Evaporator Air, but the Supply Air is not Colder than the Return Air from the Cellar

Possible Cause	Solution
Thermostat not set up properly	Check thermostat setup in the manufacture's thermostat guide
Compressor not operating	High pressure switch open (button up) (see below)
Condenser airflow is blocked	Remove blockage Clean coil (if needed)
Head Pressure (HP) switch is open	Reset HP switch – <i>see reset instructions on page 45</i>

Problems Controlling Cellar Temperature

***Problems are occurring even though the unit seems to be fully operational – evaporator fan blows air into the cellar and compressor and condenser fans run*

Cellar temperature is low (below 51° when unit is running) Possible Cause	Solution
Thermostat set too low on cooling	Reset thermostat to higher cooling temperature
Thermostat not controlling temperature	Wiring integrity compromised (shorted), replace wiring
Cellar temperature is too cold (below 51°) when unit is not running Possible Cause	Solution
Too much heat loss to adjacent spaces	Increase insulation around the ductwork and doorways - Add heater
Cellar temperature is too high, but supply air is cold Possible Cause	Solution
Not enough evaporator airflow	Remove blockage in supply or return Check and clean coil Coil frozen – shut off unit for two hours
Cellar heat loads are too high	Install additional insulation Replace with larger sized unit

Problems Controlling Cellar Humidity

<p><i>Humidity too low or supply air is too cold, without optional Standalone humidifier</i></p> <p><i>Possible Cause</i></p>	<p><i>Solution</i></p>
<p>Not enough evaporator airflow</p> <p>Defective or incorrect expansion device or coils</p>	<p>Remove blockage in supply or return ductwork Check and clean coil Coil frozen – shut off system for two hours</p> <p>Call factory for service</p>
<p><i>Humidity too low, without optional humidifier</i></p> <p><i>Possible Cause</i></p>	<p><i>Solution</i></p>
<p>No moisture being added to cellar</p>	<p>Add Wine Guardian humidifier or room humidifier</p>
<p><i>Humidity too low with optional humidifier –</i></p> <p><i>Possible Cause</i></p>	<p><i>Solution</i></p>
<p>Humidifier not operating</p> <p>Humidifier operating</p>	<p>Check wiring for loose, broke or frayed connections Check humidistat set up Check for water flow & solenoid valve operation</p> <p>Check for water being hot Check drop pad – replace if scaled No vapor barrier installed around cellar</p>
<p><i>Humidity too high when unit is running, but not cooling</i></p> <p><i>Possible Cause</i></p>	<p><i>Solution</i></p>
<p>Compressor not operating</p> <p>Ambient temperature is too high</p>	<p>Check and reset high limit switch Clear blockage of condenser airflow</p> <p>Reduce temperature or draw condenser air from another space</p>

Problems Controlling Cellar Humidity

<i>Humidity too high when unit is not running</i> <i>Possible Cause</i>	<i>Solution</i>
System needs to run to dehumidify	Lower room temperature setpoint. Seal openings around doors (gasket and sweep)
<i>Humidity too high when unit is running and cooling</i> <i>Possible Cause</i>	<i>Solution</i>
Too much moisture in cellar	Poor vapor barrier installation Humidifier malfunction refer to the humidifier instructions Add dehumidifier to surrounding space

Other Miscellaneous Problems

<i>System is leaking water</i> <i>Possible Cause</i>	<i>Solution</i>
Condensate pan plugged	Remove blockage and clean
Unit not level	Level with shims
<i>System is running properly, but the sounds of unit is objectionable</i> <i>Possible Cause</i>	<i>Solution</i>
Noise is from airflow	Duct airflow from condenser to outdoors

Manufacturer's Warranty – U.S. and Canada only

Warranty outside of the U.S. is determined by the country. Refer to your distributor for your Wine Guardian warranty.

GENERAL

Wine Guardian warrants, to the original buyer, its goods and all parts thereof to be free from defects in material and workmanship for a period of two (2) years from the date of invoicing assuming **NORMAL USE AND SERVICE**.

LIABILITY

Wine Guardian liability shall be limited to the repair or replacement (at its option) of any part, which, at our sole discretion, is determined to be defective. Wine Guardian shall pay transportation costs to and from original "ship to" address for the replacement and/or return of defective equipment.

LIMITATIONS OF LIABILITY

THESE WARRANTIES ARE MADE IN LIEU OF ALL OTHER WARRANTIES EXPRESSED OR IMPLIED, INCLUDING ANY IMPLIED WARRANTY OF MERCHANTABILITY OR FITNESS FOR A PARTICULAR PURPOSE AND IN LIEU OF ANY OTHER OBLIGATION OR LIABILITY, INCLUDING LIABILITY FOR ANY INCIDENTAL OR CONSEQUENTIAL DAMAGES. **Wine Guardian** will not be responsible for any costs or liabilities whatsoever resulting from improper installation or service of its equipment. In the event that **Wine Guardian** or its distributors are found liable for damage based on any defect or nonconformity in the products, their total liability for each defective product shall not exceed the purchase price of such defective products. **Wine Guardian** will not be responsible for the removal of defective equipment or the installation of its replacement system. No person or representative is authorized to change these warranties or assume any other obligations or liabilities for **Wine Guardian** in connection with the sale of its systems.

INDEMNIFICATION

Purchaser agrees to indemnify, hold harmless and defend seller and its officers, directors, agents and employees from and against any and all claims, liabilities, costs and expenses arising out of or related to Purchaser's use of the goods, or in any way involving injury to person or property or accident occasioned by the goods sold by **Wine Guardian** to Purchaser.

FOREIGN GOVERNMENT AND INDIAN NATIONS

If Purchaser is a foreign government or an Indian nation, Purchaser hereby expressly waives its defense of sovereign immunity in the event of a dispute between Purchaser and **Wine Guardian** regarding this invoice and Purchaser expressly acquiesces to the jurisdiction of the federal and state courts of the United States.

SEVERABILITY

If one or more of the provisions contained in this contract shall for any reason be held to be invalid, illegal or unenforceable in any respect, such invalidity, illegality or unenforceability shall not affect any provision of this contract, but this contract shall be construed as if such invalid, illegal or unenforceable provision had never been contained.

ADDITIONAL REQUIREMENTS

If a defect covered by the Warranty occurs, contact Wine Guardian for authorization to proceed with corrective action. Do not return any parts or incur any charges for which you expect to be reimbursed under this Warranty without receiving this authorization. If parts are replaced under this Warranty, the defective parts must be returned prepaid within 30 days. This warranty shall be null and void in its entirety if the Serial Number on the air conditioner or compressor is altered, removed or defaced.

Through-the-Wall Return Policy for U.S. and Canada only

TTW Warranty term

Wine Guardian warrants, to the original buyer, its goods and all parts thereof to be free from defects in material and workmanship for a period of two (2) years from the date of invoicing assuming NORMAL USE AND SERVICE. Please see “Wine Guardian Warranty” document for complete warranty coverage

Installation Instructions

Included with each Wine Guardian unit is a Quick Start Installation Guide. Each guide should be read, understood and followed prior to installation of the Wine Guardian system. Failure to do so can cause system damage, premature failure and/or improper operation of the system.

Under Warranty

If a problem develops with the Wine Guardian unit during the warranty period, the user must:

1. **Contact the Selling Dealer** - for initial trouble shooting and performance verification. Should the system be deemed defective the Selling Dealer will contact Wine Guardian’s Service Department for repair or replacement procedure. **Wine Guardian reserves the right to repair the original unit or replace the unit with either a refurbished or new unit at its discretion.**
 - a. *Unit replacement* – Wine Guardian shall send a replacement unit as a means to satisfy the warranty claim. A credit card number will be required as a means to secure the return of the defective unit. Failure to return defective unit within 30 days of shipment of replacement may result in charges to credit card. The replacement unit packaging material **MUST** be retained and used to package the defective unit for preparation of return back to Wine Guardian factory.
OR
 - b. *Unit repair* - Wine Guardian shall repair, at its N. Syracuse, New York factory, the defective unit as a means to satisfy the warranty claim. If the original packaging has been discarded, Air Innovations will send (for a fee) a replacement box and packaging materials for proper freight protection back to Wine Guardian factory. Alternatively, the unit can be packaged in a U-Haul specific “27 TV/Micro. Box” with dimensions of 24-1/2” x 24-1/2” x 27-1/2” which meets UPS and/or FedEx shipping requirements. *Please note: when using U-Haul specific box the Wine Guardian end covers must be removed to avoid damage.*
2. **Acquire Returned Goods Authorization (RGA) number** – Prior to return of any Wine Guardian unit, Wine Guardian’s Service Department will issue an RGA number which must be clearly marked on all return packaging. The RGA # provides a method for tracking the unit through Air Innovations and provides disposition upon its return.
3. **Freight** – Air Innovations shall cover the cost of freight for pick up and return of the Wine Guardian unit from the original “ship to” address. Any special handling, pick up, or drop off charges are not covered under warranty and shall be assessed and quoted prior to pick up of unit. Special handling charges shall be paid in full prior to return of system. Air Innovations shall schedule a freight carrier upon notification from the user that the system has been packaged and is ready for pickup.
4. **Removal and installation** - removal of defective units and installation of repaired or replacement systems is **NOT** covered under the Through-the-Wall warranty and it is the responsibility of the user to remove and re-install the system once the warranty issues have been addressed.

Out of Warranty

Should a problem develop with the Wine Guardian unit out of warranty you can contact Air Innovations Service Department for a quotation to diagnose and/or repair the defective system. All freight and packaging costs shall be the responsibility of the owner and shall be prepaid via check or credit card prior to any work being performed.

Contact Information

Wine Guardian

Attn: Service Department

7000 Performance Drive

N. Syracuse, New York 13212

Phone Direct: +1 315 452 7400

Phone Toll Free: +1 800 825 3268 (USA & Canada)